



- Code: FTM 1007 001
- Description: Desk with frame structure and rectangular legs

Single desks

Worktops available in different finishes and colours

Returns, links and support filing units



Optional accessories suspended on the desk frame

Moulded aluminium supports including rubber pads to hold the worktops

Aluminium frame available in different finishes

Aluminium levellers with anti-skid pad

Becnh desks



Worktops available in different finishes and colours

Optional accessories suspended on the electrification channel middle beam













Cable basket suspended on the desk beams. Cable access from the worktop

Moulded aluminium supports including rubber pads to hold the worktops.

Aluminium frame available in different finishes

Aluminium levellers with anti-skid pad

DESK-TOP FINISHES

MFC (19 mm)	Compact Laminate (13 mm)	HDF Laminate (13 mm)	Laminated security glass (5+5/6+6 mm)	Tempered security glass (10 mm)
  	 	 	   	
White Maple Wengue	White Wengue	White Wengue	Frosted Clear Blue Black	White

■ **FRAME**

Moulded aluminium legs and extruded aluminium beams. Four different finishes: Silver or White coating, Polished or Chromed



White coating



Silver coating



Polished



Chromed



Leveller - desk height: 74,5 cm

■ **ELECTRIFICATION SYSTEM**

Full length cable channel with large capacity for cables. Easy access to the cables from the worktop.

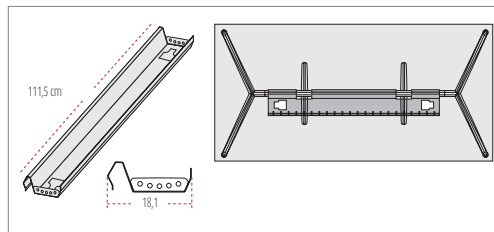

111,5 cm Channel for individual use 180 and 200 cm desks

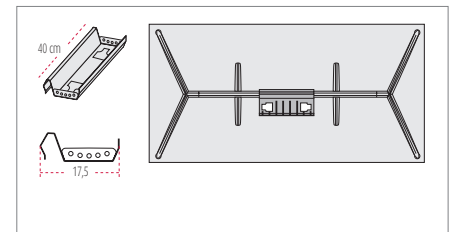

40 cm Channel for individual use 160, 180, 200 and 220 cm desks

Flip up aluminium door and metal cable box for cable access. It provides effective cable management solutions. Perfect in workplaces with several users.

Technical features:

- Large capacity for cables.
- Maximum accessibility and socket.
- Optimize work surface.
- Polished flip up door and trim.



Flip up door and metal box

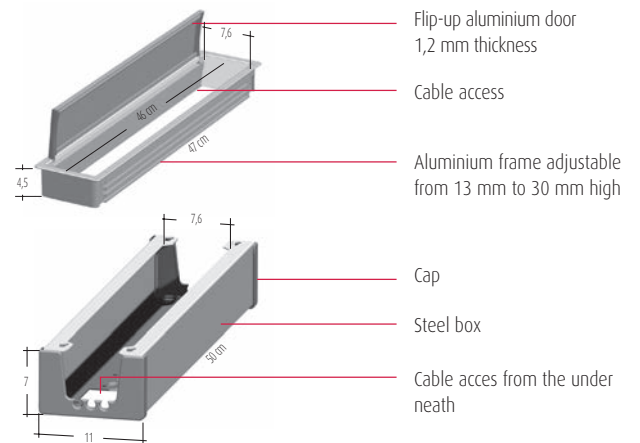

Full length cable tray.

A large steel cable tray under the worktops. Easy to access thanks to the aluminium flip up doors fixed to the central beam.

Technical features:

- Maximum capacity.
- Easy access to the cable connectors for the users as well as the technicians.
- Recommended for large projects where intensive cable capacity is required.



Full length cable tray

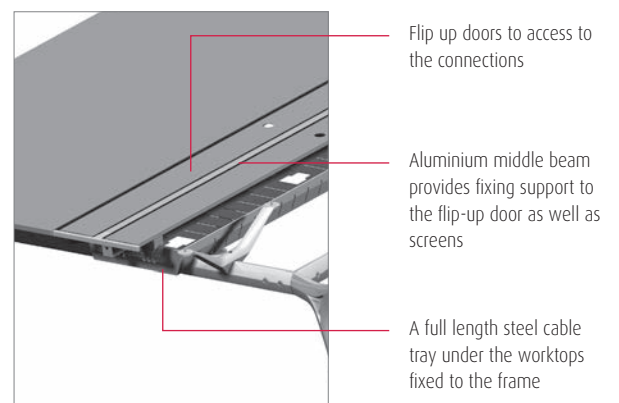

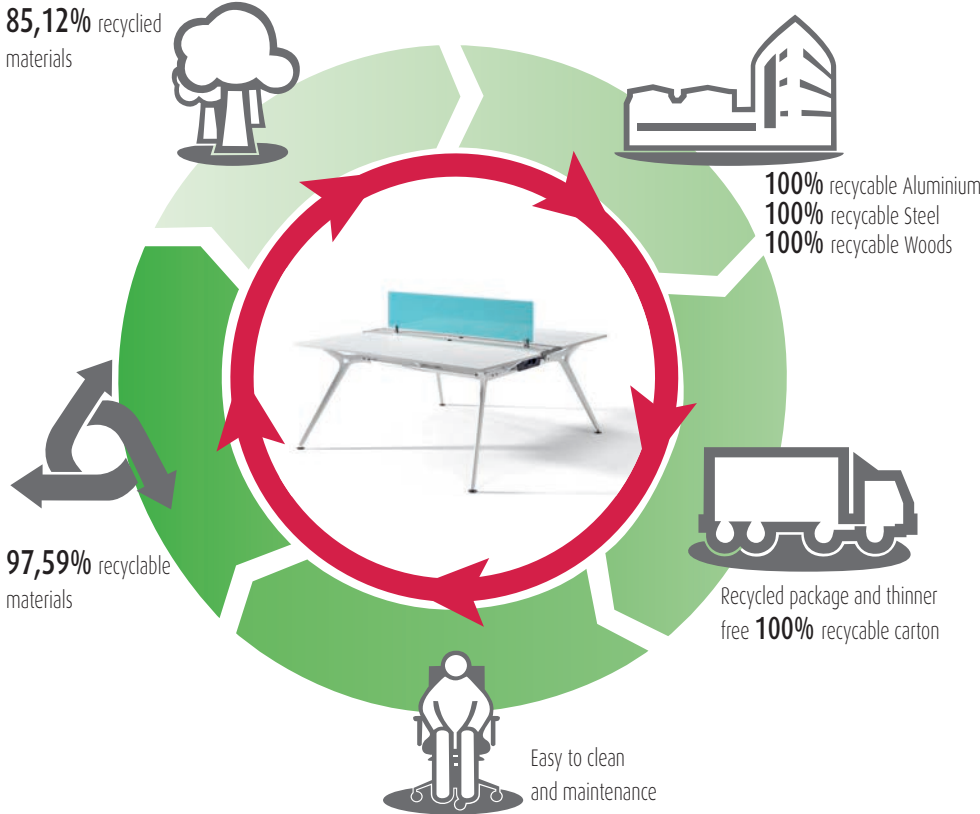

MATERIALS

ARKITEK has been designed to be manufactured with recycled materials 85,12%, danger substances such as chrome, mercury or cadmio are not used in big quantity. Recyclable Aluminium, Steel or Woods 100%. Organic volatile Components. Packages manufactured with recycled carton. Ink thinner free.

PRODUCTION

Energy use is optimized during the production process. Minimum environmental impact. Last generation technological system in coating processes. Painting that have not been used is recovered to use it again. Zero COVs emissions and other contaminant gas. Close water circuit to clean the metals. Heat recovery. Automatic manufacture systems. Cut process is planned.

TRANSPORT

Optimum packaging to reduce space in transport and save energy.

USE

Long lasting use. Spare parts and replacements available. Easy to clean and maintenance.

DISPOSAL

97,59% recyclable. Easy and quick to split ARKITEK components. Packages are reuse by our supplier to avoid waste generation. Carton used in packages is recyclable.

CERTIFICATES AND REFERENCES

The different programmes get points in different environmental categories to get the LEED certificate (sustainability, material and resources, water, energy and atmosphere, inner environment quality, innovation and design).



Responsible forest management sign.



PEFC Certificate



UNE 150301 ECODESIGN Certificate



ISO 9001 Certificate



ISO 14001 Certificate



E1 by EN 13986 Certificate



LEED Certificate U.S Green Building Council

■ ERGONOMICS

ARKITEK available for all type of users. Perfect for any need and keep user's posture in a natural way without any manual adjustment.

■ STANDARDS

ARKITEK has passed tests done in our technical department as well as the tests done in **AIDIMA** the Technological Institute for furniture. The tests correspond to UNE standards and office desks:

- **UNE: EN 527-1:2003**. Office Furniture. Desks. Part 1: Dimensions.
- **UNE: EN 527-2:2003**. Office Furniture. Desks. Part 2: Mechanical security requirements.
- **UNE: EN 527-3:2003**. Office Furniture. Desks. Part 3: Test to determine stability and structure resistance.

■ ECOLOGY**ENERGY SAVING**

The new technological production system included, reduce the energy resources used to manufacture each component. Materials are very well used to avoid wastes.

RECYCLED AND RECYCABLE MATERIALS

ACTIU environmental policy opts to use recycled materials in those components where functionality and lasting is not a condition. Materials used in **ARKITEK** such as Aluminium, Steel or Wood are totally recyclable.

SUSTAINABLE CERTIFICATE

ACTIU has **PEFC and FSC** certificate to proof that the wood used in our products comes from sustainable exploitations and **ECODESIGN ISO 14006 certificate**.

■ REMARKABLE VALUES

1 – Legs covered with epoxy coating, bonding 2nd generation polymerized 200°C. Non-greasy treatments and nano-ceramics application to improve the coating so it becomes more resistance and long-lasting.

2 – Coating 80-90 micron thickness (it could be different as per the project requirements)

This covering guarantees the finish and maintenance of metal structures.

3 – Painting process:

Actiu painting plant has minimum environmental impact against the traditional industry processes.

Treatment is done by polarized coating and compacted with temperature. We get homogeneous and regular application with 98% of painting and the remaining 2% is used to produce other paints. Paints used are COVs free (Volatile Organic Components) which are very dangerous for the environment. All water used in the process is re-used, so we get zero dump. The process is free in heavy metal, phosphate, organic components and DQD (Biochemical demand of Oxygen). The program gives us an exact control of thickness, so it provides us with standard thickness (80-90 micron). Antibacterial finish

4 – ACTIU has **PEFC and FSC** certificate to proof that the wood used in our products comes from sustainable exploitations and **ECODESIGN ISO 14006 certificate**.

5 – **Optional** accessories fixed to the beams, modesty panels, screens, CPU holders or fixed pedestals.

■ TEXT REQUIREMENTS

ARKITEK

Architectonic style leg with vertical “Y” shape. It is manufactured of solid aluminium. In those points where the leg is more voluminous, is hexagonal shape (similar to a 6 side’s rhombus) which is only 3 sides in the leveler point and 4 sides in the support point.

The **leveler** is composed of a round aluminium plate 52 mm thickness.

The **point** where the leg, the top support and the beam fixing are merged together is an empty aluminum mass with triangle shape.

The **beam** is manufactured by extruded aluminium and it is composed by an inner flat bar 40 x 15 mm thickness to reinforce the frame. This is covered by another exterior plate with hexagonal shape.